

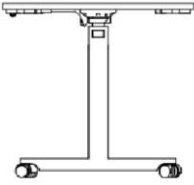



FLIPPER Klapptisch







Produktübersicht

| TISCHE | |
|------------------|--|
| |   |
| [B x T x H] | INDEX |
| 1390 x 695 x 735 | FLI-SW-003 |
| 1600 x 800 x 735 | FLI-SW-002 |

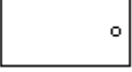

Zubehör



| Kabelführung vertikal | | | Verbinder für Tische | | Netbox Point | |
|---|---------------|---------------|---|---------------|---|---------------|
| | [W x D x H] | Artikelnummer | | Artikelnummer | | Artikelnummer |
|  | 83 x 30 x 470 | AKC-OK-470 |  | AKC-IN-140 |  | AKC-PK-080 |

Optionen

| Kabeldurchlass | | | Strom-Data-Box | | |
|--|-------------|----------------|---|---------|---------------|
| | Maß [Ø] | Artikelnummer | | Maß [Ø] | Artikelnummer |
|     | Ø 80 | K1 K2 K3 |  USB / DE / RJ   | Ø 80 | M10 M30 |
| KABELDURCHLASS AUS ALUMINIUM | | | | | |
| | Maß [B x T] | | Artikelnummer | | |
|  | 256 x 100 | | F70 | | |

Farbübersicht

| MCF | | | | | | |
|---|---|---|--|--|--|--|
|  |  |  | | | | |
| ABB | AAK | ADR | | | | |

| GESTELLFARBE | |
|---|---|
|  |  |
| JMJ | JBB |

